

FLEX

Flexibler Rohrheizkörper
Flexible Tubular Heaters

4.0



TÜRK+HILLINGER
THERMAL TECHNOLOGY

FLEXIBLER ROHRHEIZKÖRPER FLEXIBLE TUBULAR HEATERS

Der FLEX ist ein robuster Rohrheizkörper, mit sehr guten thermischen Eigenschaften, der frei von Hand gebogen werden kann. Die Handhabung ist einfach. Je nach Anwendungsfall kann der Rohrheizkörper - ohne Spezialwerkzeuge - in alle drei Dimensionen gebogen werden.

Türk+Hillinger bietet für den FLEX zahlreiche Durchmesser und Querschnitte in unterschiedlichen Längen **direkt ab Lager** an.

Für den Anwender hat der FLEX große Vorteile in der Lagerhaltung, dadurch, dass er im Bedarfsfall einfach und schnell in die benötigte Form gebogen werden kann. Nutzen auch Sie die Flexibilität unseres FLEX für Ihren Einsatz.

Prüfung

Die flexiblen Rohrheizkörper entsprechen den VDE-Vorschriften. Alle FLEX werden einer Stückprüfung nach DIN EN 60335 (VDE 0700) unterzogen.

The FLEX is a robust tubular heating element with excellent thermal properties, which can freely be bent by hand. The handling is easy. Depending on the application, the tubular heater - without special tooling - can be bent in all three dimensions.

Türk+Hillinger offers the FLEX **direct from stock**, in numerous diameters and cross sections.

For the user, the FLEX provides great advantages in warehousing. If necessary, the tubular heater can be bent easily and quickly into the required form. Take advantage of the flexibility of our FLEX for your own operations.

Testing

T+H flexible tubular heaters comply with VDE standards. Each heater must undergo an individual test i.a.w. DIN EN 60335 (VDE 0700).

Technische Eigenschaften

Mantelmaterial	Edelstahl
Heizelement Manteltemperatur	700°C
Standard Anschluss-Spannung	230 V
Hochspannungsfestigkeit*	1.000 V AC
Isolationswiderstand*	≥ 5 MΩ bei 500 V DC
Ableitstrom*	< 0,5 mA bei 253 V AC
Leistungstoleranz	+/- 10%
Längentoleranz	+/- 3 mm

* geprüft bei Raumtemperatur

Optionen

Ausführung mit biegbaren, unbeheizten Zonen

- Anschluss-Spannungen von 12 V bis 250 V
- individuelle Länge
- individuelle Anschlussausführung
- individuelle Leistungen

Technical Properties

Sheath material	Stainless steel
Heat element sheath temperature	700°C
Standard connection voltage	230 V
Dielectric strength*	1.000 V AC
Insulation resistance*	≥ 5 MΩ at 500 V DC
Leakage current*	< 0,5 mA at 253 V AC
Power tolerance	+/- 10%
Length tolerance	+/- 3 mm

* tested at room temperature

Options

Execution with bendable, unheated zones

- Connection voltage from 12 V to 250 V
- Individual length
- Individual connection execution
- Individual power



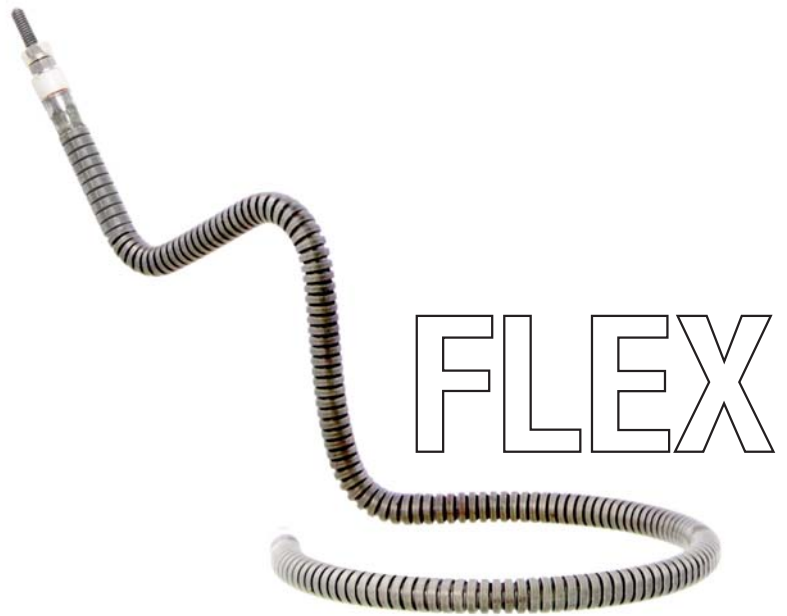

Empfohlene Nutgeometrie

Typ FLEX	Nutabmessung [mm] b x h		
□ 6,0 ±0,1	6,1 ^{+0,1}	X	7,1 ^{+0,1}
∅ 6,5 ±0,1	6,0 ^{+0,1}	X	6,5 ^{+0,1}
∅ 8,0 ±0,1	7,7 ^{±0,05}	X	8,0 ^{±0,1}
□ 8,0 ±0,1	8,1 ^{+0,1}	X	9,1 ^{+0,1}
∅ 8,5 ±0,1	8,2 ^{±0,05}	X	8,5 ^{±0,1}
∅ 9,52 ±0,1	9,2 ^{±0,1}	X	9,5 ^{±0,1}

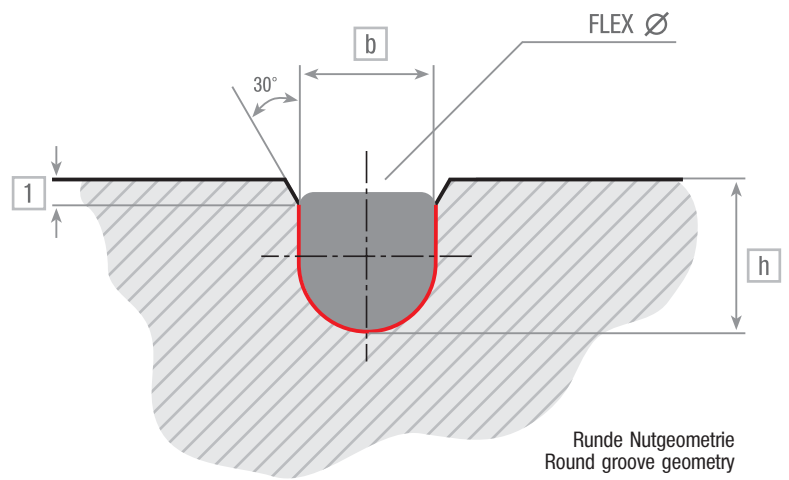

Recommended Groove Geometry

Type FLEX	Groove Dimension [mm] b x h		
□ 6,0 ±0,1	6,1 ^{+0,1}	X	7,1 ^{+0,1}
∅ 6,5 ±0,1	6,0 ^{+0,1}	X	6,5 ^{+0,1}
∅ 8,0 ±0,1	7,7 ^{±0,05}	X	8,0 ^{±0,1}
□ 8,0 ±0,1	8,1 ^{+0,1}	X	9,1 ^{+0,1}
∅ 8,5 ±0,1	8,2 ^{±0,05}	X	8,5 ^{±0,1}
∅ 9,52 ±0,1	9,2 ^{±0,1}	X	9,5 ^{±0,1}

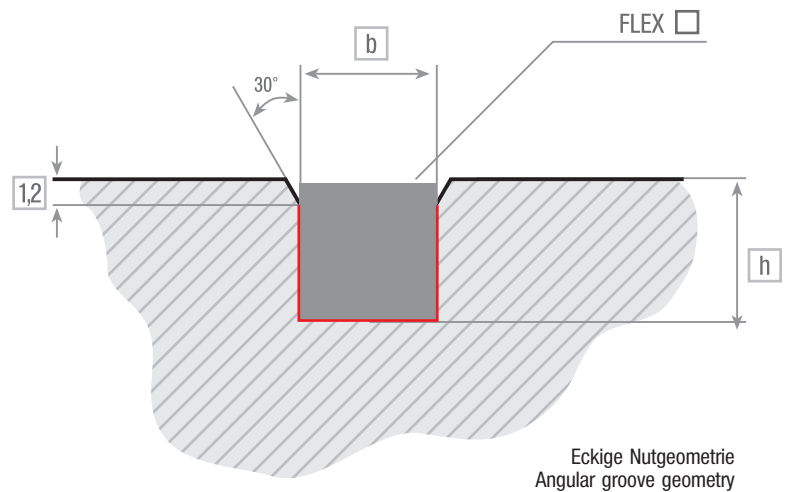

Vorteile

- Flexibler, von Hand biegbarer Rohrheizkörper
- Einfacher Einbau
- Kein Spezialwerkzeug nötig
- 3-dimensionale Nutgeometrie möglich
- Geringe Biegeradien möglich
- Einfache Lagerhaltung

Advantages

- Flexible tubular heater, bendable by hand
- Simple installation
- No special tooling required
- 3-dimensional groove geometry possible
- Low bending radius possible
- Simple warehousing

FLEX

STECKVERBINDUNG FLEX PLUG CONNECTION FLEX

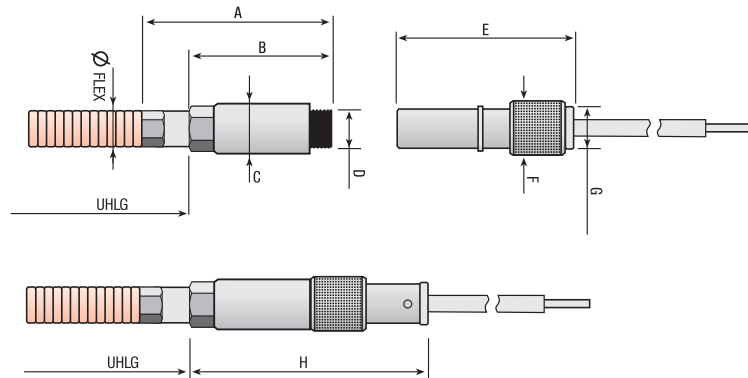
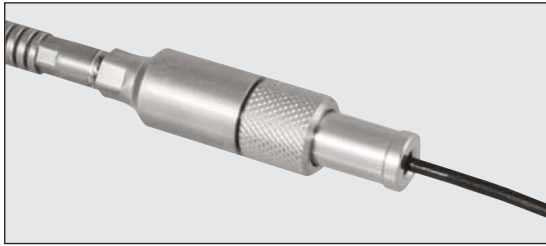

Technische Daten:

Strombelastbarkeit bis zu 20A
Temperaturbeständigkeit 260°C
Leiterquerschnitt bis zu 2,5 mm²

Technical specifications:

Current Rating up to 20A
Temperature resistance 260°C
Leads cross section up to 2,5 mm²

	FLEX Ø 6,5 / □ 6x6 [mm]	FLEX Ø 8,0 / 8,5 / □ 8x8 [mm]
A	ca. 40,2	ca. 38,4
B	29,7	31,9
C	Ø 12	Ø 12
D	M10 x 1	M10 x 1
E	34,2	34,2
F	Ø 12	Ø 12
G	Ø 8,6	Ø 8,6
H	ca. 47,9	ca. 50,1

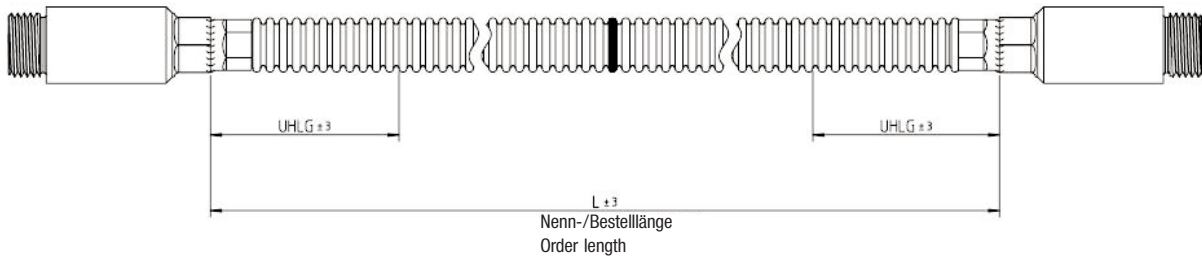

Typ Type FLEX	L min [mm]	L max [mm]	Rohrstück Tubular piece max [mm]	Mindestbiegeradius Min. bending radius innen / inner diameter
□ 6,0	300	1.800	24	6,5
Ø 6,5	300	1.800	24	6,5
Ø 8,0	300	2600	10	10
□ 8,0	300	2600	10	10
Ø 8,5	300	2600	10	10

Hinweis:

Abhängig von der Anzahl der Biegeradien wird der FLEX beim Biegen und Einpressen länger.

Caution:

Depending on the quantities of the bending radii, the FLEX elongates during the bending process and insertion into the groove.

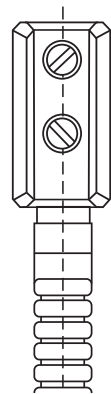
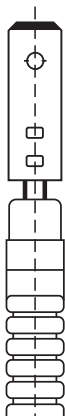
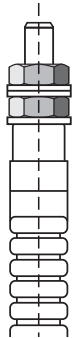
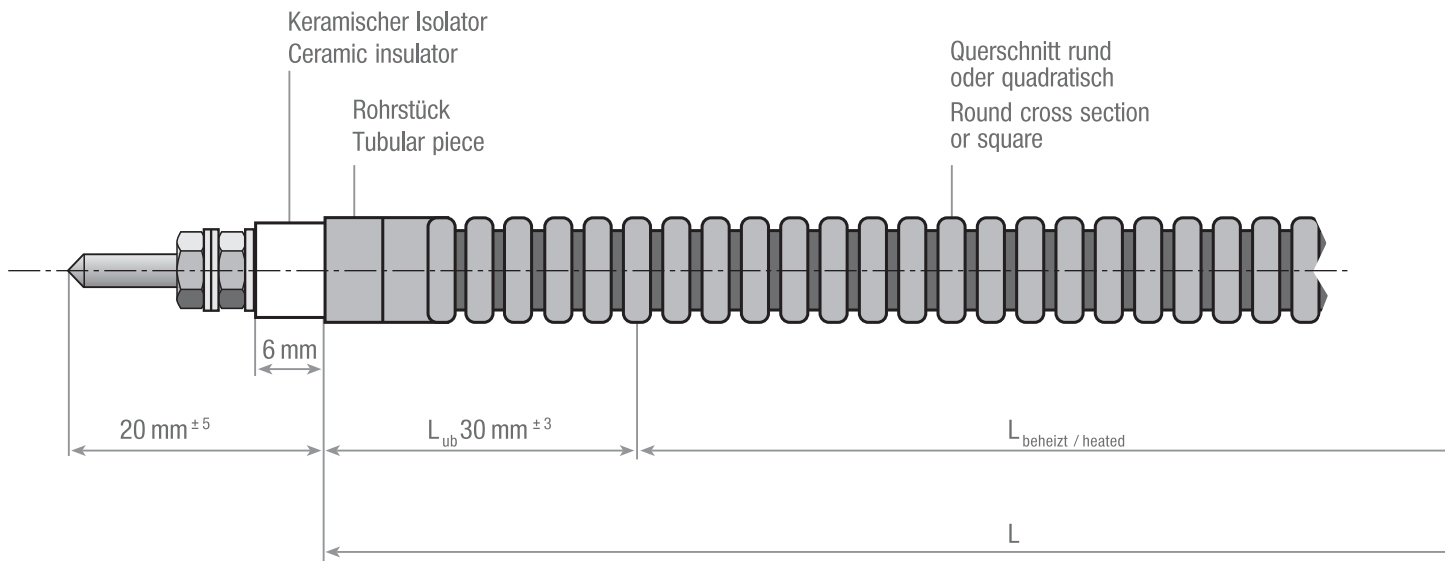

<p>Gewindeanschluss M2,5 Optional: M4 bei $\varnothing \geq 8 \text{ mm}$</p> <ul style="list-style-type: none"> - mit Satz Muttern und Scheiben, Temperaturbeständigkeit 350°C 	<p>Flachstecker</p> <ul style="list-style-type: none"> - B = 6,3 mm - Temperaturbeständigkeit 350°C 	<p>isolierte Leitungen</p> <ul style="list-style-type: none"> - Glasfaser (LEGLS) bis 250/350°C * - PTFE (LETEF) bis 260°C - Silikon (LESIL) bis 200°C - optional: Kabelschuh für M4 * kurzzeitige Temp. 	<p>Nickel-Leitung</p> <ul style="list-style-type: none"> - mit Keramikperlen, bis 650°C 	<p>Keramikklemme</p> <ul style="list-style-type: none"> - Temperaturbeständigkeit 230°C, bis max. 280°C kurzzeitig - 14 x 21 x 25 mm
<p>Thread connector M2,5 Option: M4 at $\varnothing \geq 8 \text{ mm}$</p> <ul style="list-style-type: none"> - with set of nuts and washers, temperature resistance 350°C 	<p>Plug connector</p> <ul style="list-style-type: none"> - B = 6,3 mm - Temperature resistance 350°C 	<p>insulated leads</p> <ul style="list-style-type: none"> - Fiberglass (LEGLS) up to 250/350°C * - PTFE (LETEF) up to 260°C - Silicone (LESIL) up to 200°C - optional: terminal for M4 * short time temp. 	<p>Nickel leads</p> <ul style="list-style-type: none"> - with ceramic beads, up to 650°C 	<p>Ceramic clamp</p> <ul style="list-style-type: none"> - temperature resistance 230°C, up to max 280°C short time - 14 x 21 x 25 mm

LAGERLISTE STOCK TYPE HEATERS

RUND / ROUND

Ø 6,5 / 230V			Ø 8,0 / 230V			Ø 8,5 / 230V		
Art. Nr. Art. No.	L [mm]	P [W]	Art. Nr. Art. No.	L [mm]	P [W]	Art. Nr. Art. No.	L [mm]	P [W]
107500	300	350	104500	400	800	104400	300	650
107501	350	400	104526	450	900	104413	350	750
107502	400	500	104501	500	1000	104401	400	900
107503	450	600	104527	550	1150	104414	450	1050
107504	500	650	104502	600	1250	104402	500	1150
107505	550	700	104528	650	1400	104415	550	1300
107506	600	800	104503	700	1500	104403	600	1450
107507	650	850	104529	750	1600	104416	650	1600
107508	700	900	104504	800	1700	104404	700	1750
107509	750	1000	104531	850	1850	104417	750	1900
107510	800	1100	104505	900	2000	104405	800	2050
107511	850	1200	104532	950	2100	104418	850	2200
107512	900	1300	104506	1000	2200	104406	900	2350
107513	950	1350	104533	1050	2300	104419	950	2500
107514	1000	1400	104507	1100	2400	104407	1000	2650
107515	1050	1450	104534	1150	2550	104420	1050	2800
107516	1100	1500	104508	1200	2650	104408	1100	2950
107517	1150	1550	104535	1250	2800	104424	1150	3050
107518	1200	1600	104509	1300	2900	104409	1200	3200
107519	1250	1650	104537	1350	3000	104425	1250	3300
107520	1300	1700	104510	1400	3100	104410	1300	3450
107521	1350	1800	104538	1450	3250	104426	1350	3600
107522	1400	1900	104511	1500	3350	104411	1400	3700
107523	1450	2000	104539	1550	3500	104427	1450	3850
107524	1500	2100	104512	1600	3600	104412	1500	4000

LAGERLISTE STOCK TYPE HEATERS

ECKIG / ANGULAR

□ 6 x 6 / 230V			□ 8 x 8 / 230V		
Art. Nr. Art. No.	L [mm]	P [W]	Art. Nr. Art. No.	L [mm]	P [W]
107525	300	450	104514	300	750
107526	400	650	104515	400	1050
107527	500	800	104516	500	1400
107528	600	1000	104517	600	1700
107529	700	1200	104518	700	2000
107530	800	1350	104519	800	2300
107531	900	1550	104520	900	2600
107532	1000	1750	104521	1000	2900
107533	1100	1950	104522	1100	3200
107534	1200	2100	104523	1200	3300
107535	1300	2300	104524	1300	3300
107536	1400	2500	104525	1400	3300
107537	1500	2700	104513	1500	3500

IHR KOMPETENTER PARTNER YOUR COMPETENT PARTNER

Wärmstens möchten wir Ihnen unsere neuesten, aber auch unsere etablierten Entwicklungen auf dem Gebiet der elektrischen Beheizungs-technik empfehlen.

We highly recommend our established wide range of products as well as our latest developments in the field of electric heating elements.

- **Rohrheizkörper Typ RHK**
Tubular heater type RHK
- **Einschraubheizkörper Typ EHK**
Immersion heaters type EHK
- **Hochleistungs-Heizpatronen Typ HLP**
High performance cartridge heater type HLP
- **Hochleistungs-Rohrpatronen Typ RP/RPT**
Tubular cartridge heaters type RP/RPT
- **Luftheritzer**
Air heater
- **Hohlpatronen Typ HPQ**
Nozzle heaters type HPQ
- **Thermoelemente Typ TE**
Temperature sensors type TE

Türk+Hillinger GmbH
Föhrenstr. 20
D-78532 Tuttlingen
Tel. 0 74 61-70 140 Fax 70 14 110

Türk+Hillinger Elektrowärme GmbH
Dorotheenstr. 22
D-09212 Limbach-Oberfrohna
Tel. 0 37 22-71 89 0 Fax 71 89 16

info@turk-hillinger.de
www.tuerk-hillinger.de

Türk+Hillinger USA, Inc.
6650 W. Snowville Road, Suite W
P.O. Box 41371
Brecksville, Ohio 44141, USA

Tel. +1 440-512 71 44
Fax +1 440-512 71 45
info@turk-hillinger.us
www.turk-hillinger.us



TURK+HILLINGER
THERMAL TECHNOLOGY